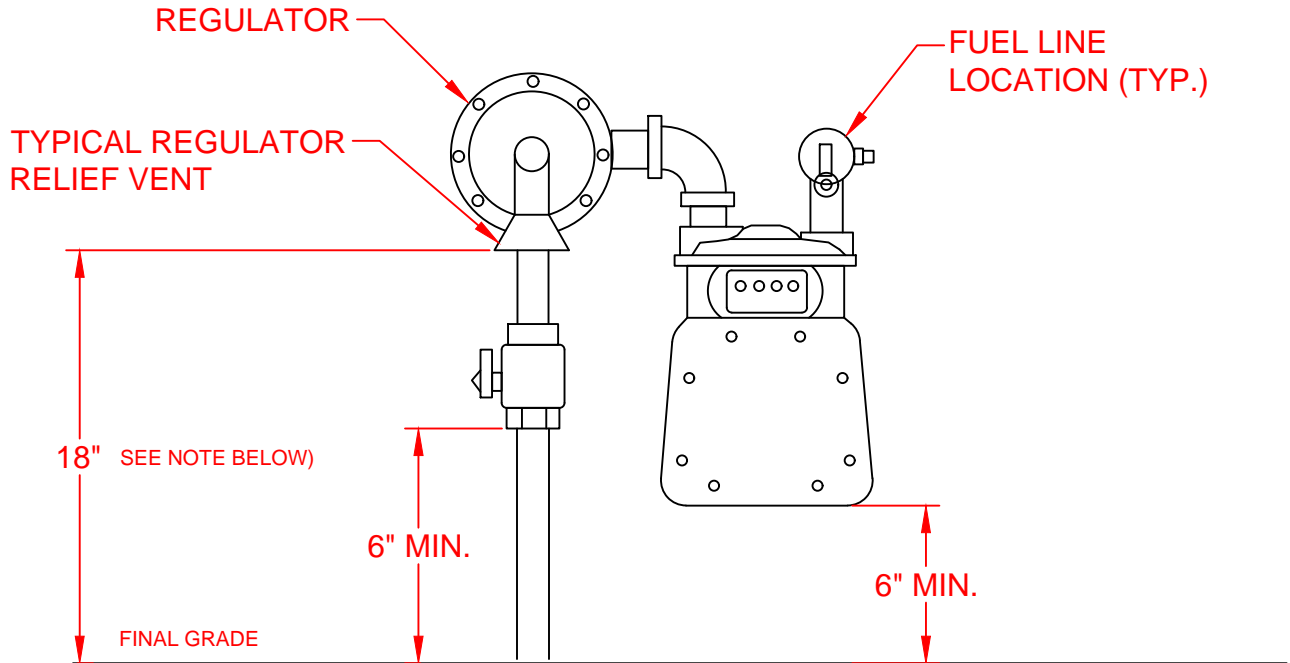

DIAGRAM A

GAS METER CLEARANCES TO FINAL GRADE
(250 METER)



NOTE:

THE STANDARD INSTALLATION HEIGHT OF THE REGULATOR VENT IS APPROXIMATELY 28" FROM FINAL GRADE. HOWEVER, IF LOCAL CONDITIONS PREVENT THE STANDARD INSTALLATION, THE HEIGHT, WITH PRIOR SUPERVISORY APPROVAL, CAN BE REDUCED FOR THE INSTALLATION. UNDER NO CIRCUMSTANCES CAN THE HEIGHT BE REDUCED TO LESS THAN 18"

						DRAWN				
						JNM				
						CHECKED				
						CL	UNITIL GAS STANDARDS (NH)			
						APPROVED	GAS METER SET ASSEMBLIES			
						CL	INSTALLATION REQUIREMENTS			
A	REVISED FOR SINGLE STATE	JEH	10/08/24	SM	SM	SCALE	DATE	SHEET	DRAWING NO.	
REV.	DESCRIPTION	BY	DATE	CHK	APR	N/A	4/3/12	1 OF 6	UAYMX001	
REVISIONS										

DIAGRAM B

MEASURING AROUND A BUILDING CORNER REGULATOR CLEARANCE

OUTSIDE CORNERS:

- CLEARANCE DISTANCES FROM THE REGULATOR RELIEF VENT OR METER SET ASSEMBLY TO THE FEATURE(S) MUST BE MAINTAINED IN ACCORDANCE WITH THE APPLICABLE IGNITION SOURCE/OPENING FEATURE CLEARANCE REQUIREMENT DIAGRAM. *MEASURE AS IF USING A STRING.*

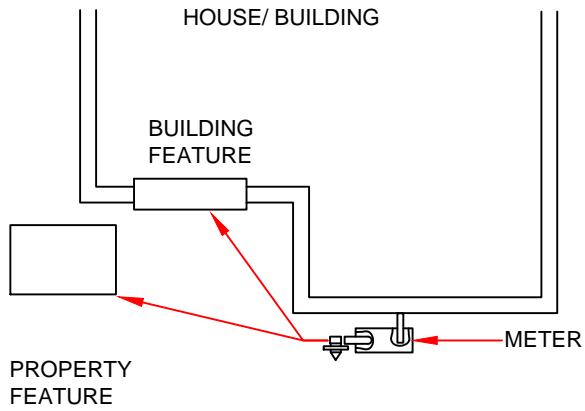

PLAN VIEW

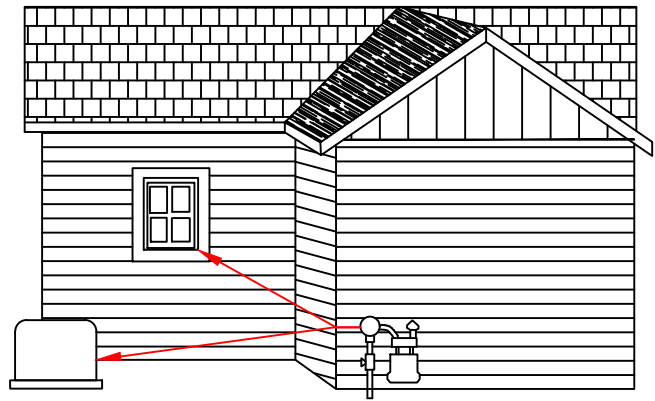

ELEVATION VIEW

REV.	DESCRIPTION	BY	DATE	CHK	APR
B	REVISED FOR SINGLE STATE	JEH	10/08/24	SM	SM
A	REVISED NOTATION	JEH	10/07/22	SM	SM
REVISIONS					

DRAWN	JNM
CHECKED	CL
APPROVED	CL

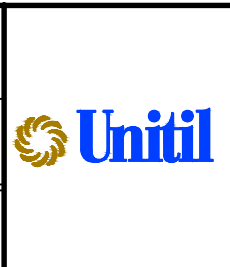

UNITIL GAS STANDARDS (NH) GAS METER SET ASSEMBLIES INSTALLATION REQUIREMENTS			
SCALE	DATE	SHEET	DRAWING NO.
N/A	4/3/12	2 OF 6	UAYMX001

DIAGRAM C

MEASURING AROUND A BUILDING CORNER REGULATOR CLEARANCE

INSIDE CORNERS:

CLEARANCE DISTANCES FROM THE REGULATOR RELIEF VENT OR METER SET ASSEMBLY TO THE FEATURE(S) MUST BE MAINTAINED IN ACCORDANCE WITH THE APPLICABLE IGNITION SOURCE/OPENING FEATURE CLEARANCE REQUIREMENT DIAGRAM. *MEASURE AS IF USING A STRING.*

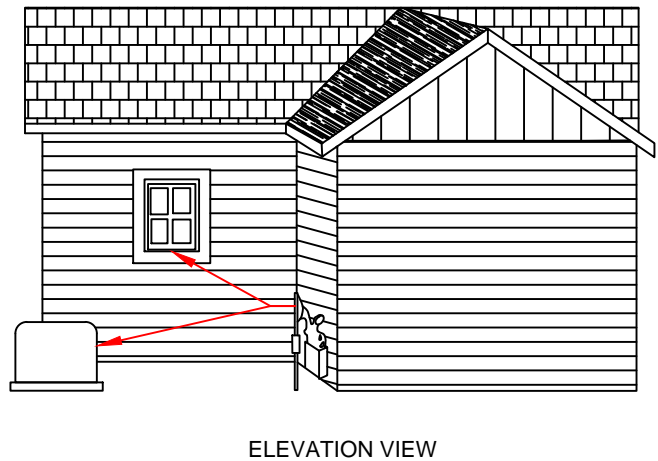
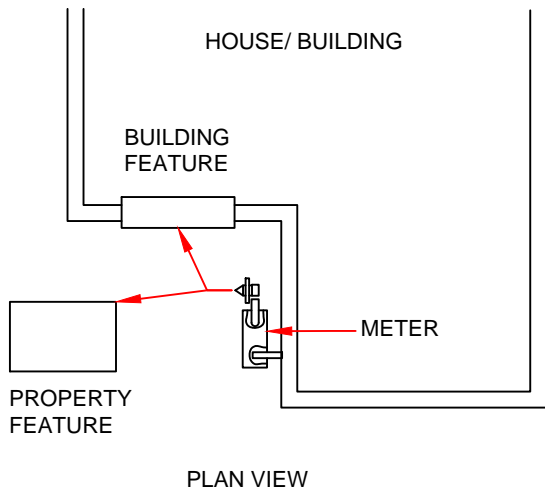

REV.	DESCRIPTION	BY	DATE	CHK	APR
B	REVISED FOR SINGLE STATE	JEH	10/08/24	SM	SM
A	REVISED NOTATION	JEH	10/07/22	SM	SM
REVISIONS					

DRAWN	JNM
CHECKED	CL
APPROVED	CL

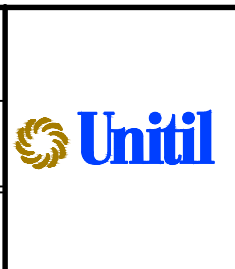

UNITIL GAS STANDARDS (NH) GAS METER SET ASSEMBLIES INSTALLATION REQUIREMENTS			
SCALE	DATE	SHEET	DRAWING NO.
N/A	4/3/12	3 OF 6	UAYMX001

DIAGRAM D

REGULATOR RELIEF VENT CLEARANCES FROM FEATURES

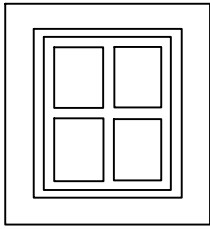

WINDOW OPENING

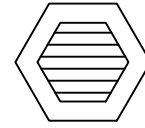

ATTIC VENT OPENING

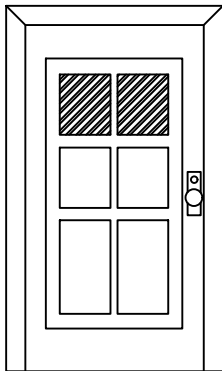

DOORS

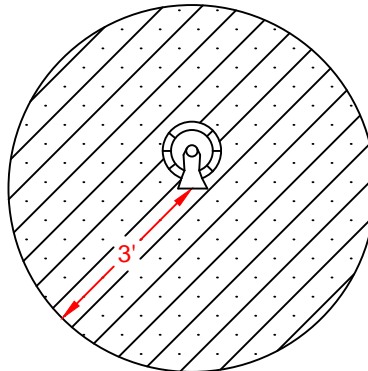

NO FEATURES TO BE PLACED WITHIN TOLERANCE ZONE (CROSS-HATCHED AREA)

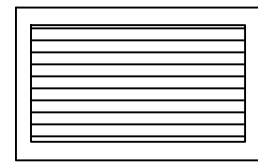

AIR INTAKE OPENING

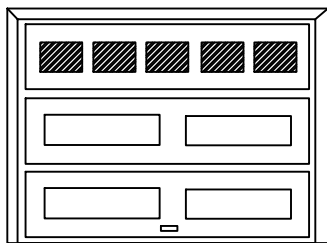

GARAGE DOORS



CRAWL SPACE OR GARAGE VENT OPENING

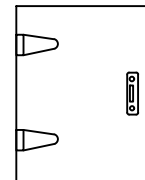

FIREPLACE CLEANOUT OPENING

REV.	DESCRIPTION	BY	DATE	CHK	APR
A	REVISED FOR SINGLE STATE	JEH	10/08/24	SM	SM
REVISIONS					

DRAWN	JNM
CHECKED	CL
APPROVED	CL



UNITIL GAS STANDARDS (NH) GAS METER SET ASSEMBLIES OPENING FEATURES			
SCALE	DATE	SHEET	DRAWING NO.
N/A	11/03/22	4 OF 6	UAYMX001

DIAGRAM E

REGULATOR RELIEF VENT CLEARANCES FROM FEATURES

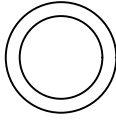

APPLIANCE COMBUSTION
AIR INTAKE VENT OPENING

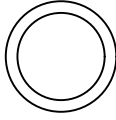

APPLIANCE EXHAUST
VENT OPENING

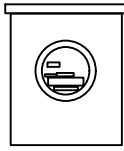

ELECTRIC METER

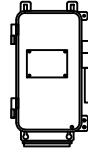

DISCONNECT

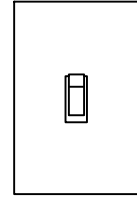

WALL SWITCH

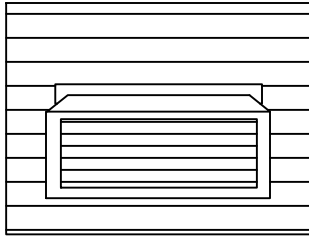

WALL MOUNTED
AIR CONDITIONER

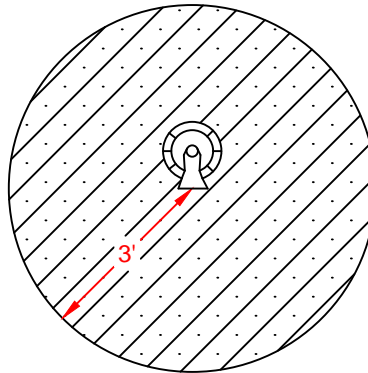

NO FEATURES TO BE PLACED
WITHIN TOLERANCE ZONE
(CROSS-HATCHED AREA)

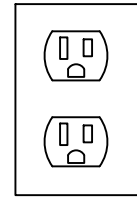

ELECTRIC OUTLET

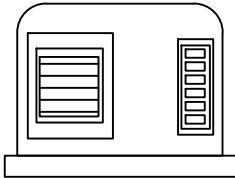

AIR CONDITIONER
OR HEAT PUMP

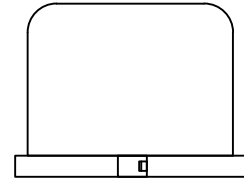

GENERATOR OR
TRANSFORMER

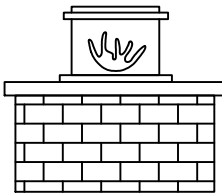

OPEN FLAME OR
PERMANENT BBQ

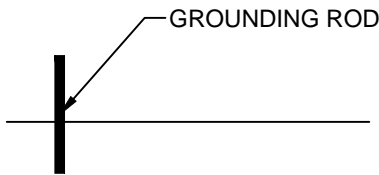

GROUNDING ROD

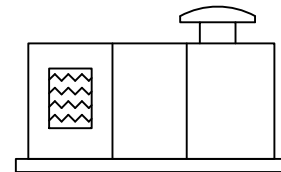

INCINERATOR

REV.	DESCRIPTION	BY	DATE	CHK	APR
A	REVISED FOR SINGLE STATE	JEH	10/08/24	SM	SM
REVISIONS					

DRAWN
JNM
CHECKED
CL
APPROVED
CL



UNITIL GAS STANDARDS (NH)
GAS METER SET ASSEMBLIES
IGNITION FEATURES

SCALE N/A	DATE 11/03/22	SHEET 5 OF 6	DRAWING NO. UAYMX001
--------------	------------------	-----------------	-------------------------

DIAGRAM F

REGULATOR RELIEF VENT
CLEARANCES FROM FEATURES

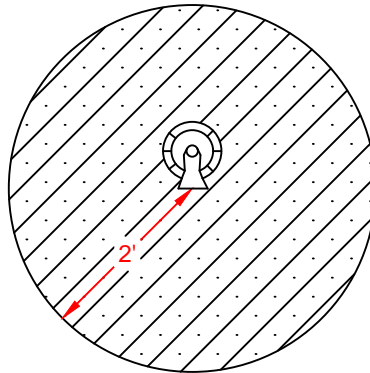

NO FEATURES TO BE PLACED
WITHIN TOLERANCE ZONE
(CROSS-HATCHED AREA)

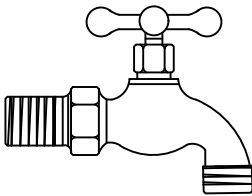

WATER SPIGOT

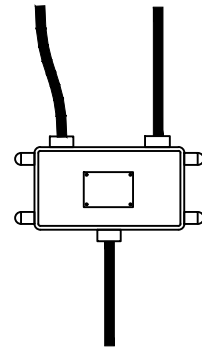

COMMUNICATIONS BOX

REV.	DESCRIPTION	BY	DATE	CHK	APR
A	REVISED FOR SINGLE STATE	JEH	10/08/24	SM	SM
REVISIONS					

DRAWN	JNM
CHECKED	CL
APPROVED	CL

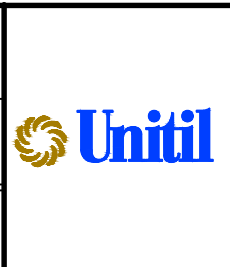

UNITIL GAS STANDARDS (NH) GAS METER SET ASSEMBLIES OTHER FEATURES			
SCALE	DATE	SHEET	DRAWING NO.
N/A	11/03/22	6 OF 6	UAYMX001