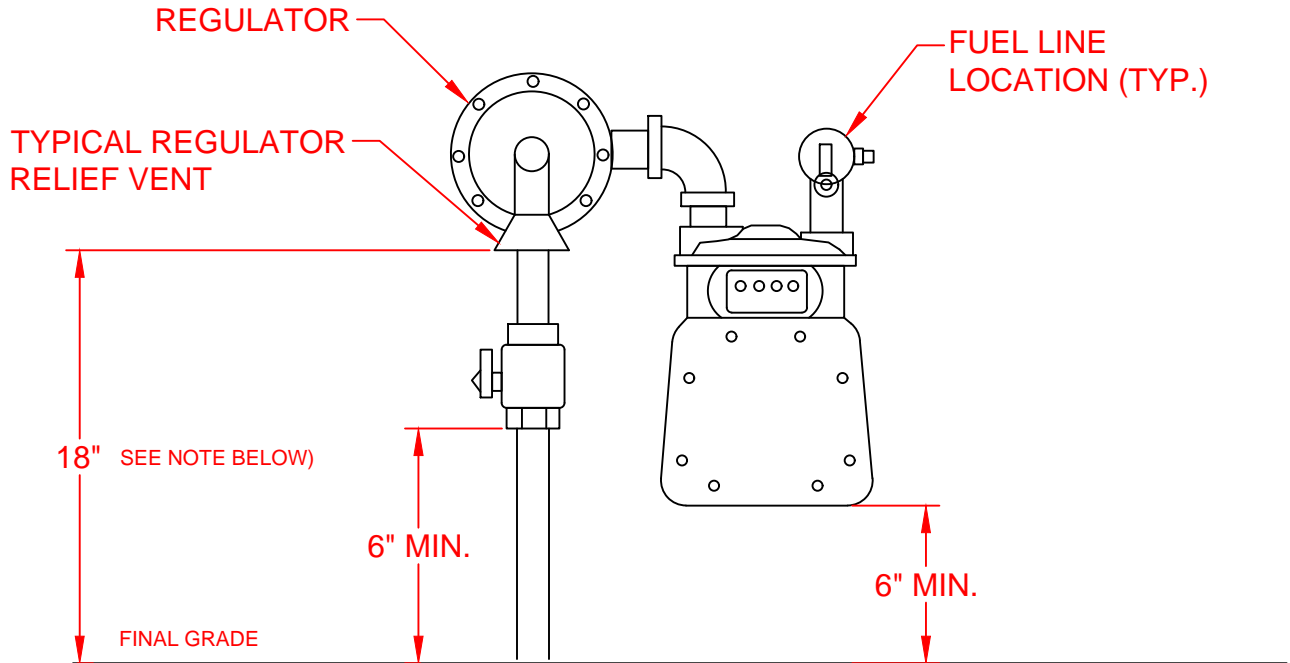

DIAGRAM A

GAS METER CLEARANCES TO FINAL GRADE
(250 METER SHOWN)



NOTE:

THE STANDARD INSTALLATION HEIGHT OF THE REGULATOR VENT IS APPROXIMATELY 28" FROM FINAL GRADE. HOWEVER, IF LOCAL CONDITIONS PREVENT THE STANDARD INSTALLATION, THE HEIGHT, WITH PRIOR SUPERVISORY APPROVAL, CAN BE REDUCED FOR THE INSTALLATION. UNDER NO CIRCUMSTANCES CAN THE HEIGHT BE REDUCED TO LESS THAN 18"

						DRAWN								
						JNM								
						CHECKED								
						CL								
						APPROVED								
						CL								
REVISIONS										UNITIL GAS STANDARDS (MA) GAS METER SET ASSEMBLIES INSTALLATION REQUIREMENTS				
REV.	DESCRIPTION	BY	DATE	CHK	APR	SCALE	DATE	SHEET	DRAWING NO.					
A	REVISED FOR SINGLE STATE	JEH	10/08/24	SM	SM	N/A	10/8/24	1 OF 7	UAYMX006					

DIAGRAM B

MEASURING AROUND A BUILDING CORNER REGULATOR CLEARANCE

OUTSIDE CORNERS:

- CLEARANCE DISTANCES FROM THE REGULATOR RELIEF VENT OR METER SET ASSEMBLY TO THE FEATURE(S) MUST BE MAINTAINED IN ACCORDANCE WITH THE APPLICABLE IGNITION SOURCE/OPENING FEATURE CLEARANCE REQUIREMENT DIAGRAM. *MEASURE AS IF USING A STRING.*

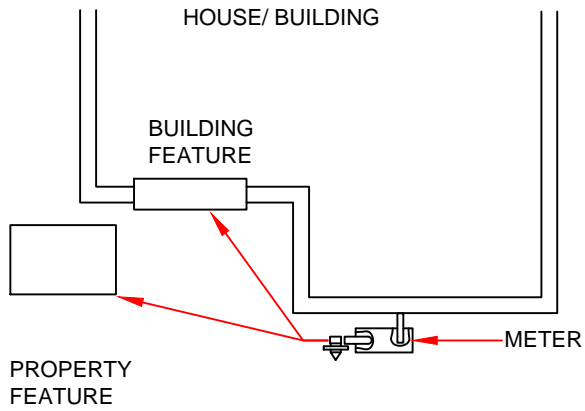

PLAN VIEW

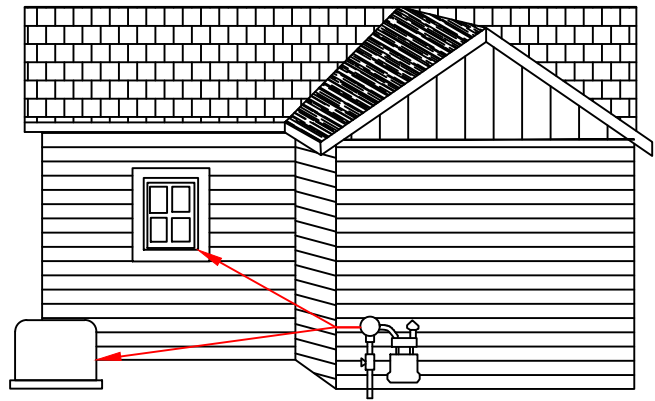

ELEVATION VIEW

REV.	DESCRIPTION	BY	DATE	CHK	APR
B	REVISED FOR SINGLE STATE	JEH	10/08/24	SM	SM
A	REVISED NOTATION	JEH	10/07/22	SM	SM
REVISIONS					

DRAWN	JNM
CHECKED	CL
APPROVED	CL



UNITIL GAS STANDARDS (MA)
GAS METER SET ASSEMBLIES
INSTALLATION REQUIREMENTS

SCALE	DATE	SHEET	DRAWING NO.
N/A	10/8/24	2 OF 7	UAYMX006

DIAGRAM C

MEASURING AROUND A BUILDING CORNER REGULATOR CLEARANCE

INSIDE CORNERS:

CLEARANCE DISTANCES FROM THE REGULATOR RELIEF VENT OR METER SET ASSEMBLY TO THE FEATURE(S) MUST BE MAINTAINED IN ACCORDANCE WITH THE APPLICABLE IGNITION SOURCE/OPENING FEATURE CLEARANCE REQUIREMENT DIAGRAM. *MEASURE AS IF USING A STRING.*

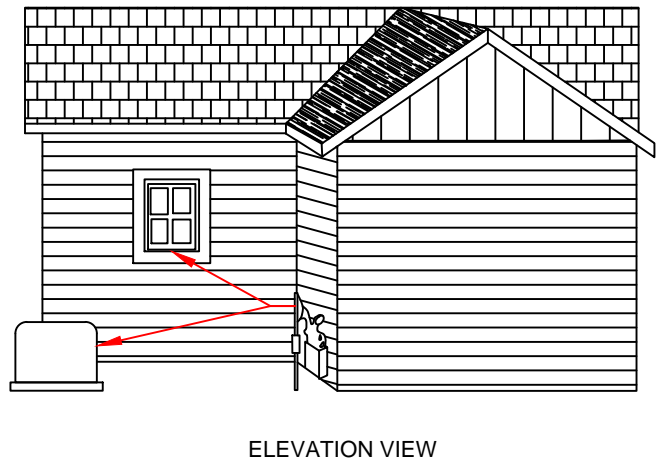
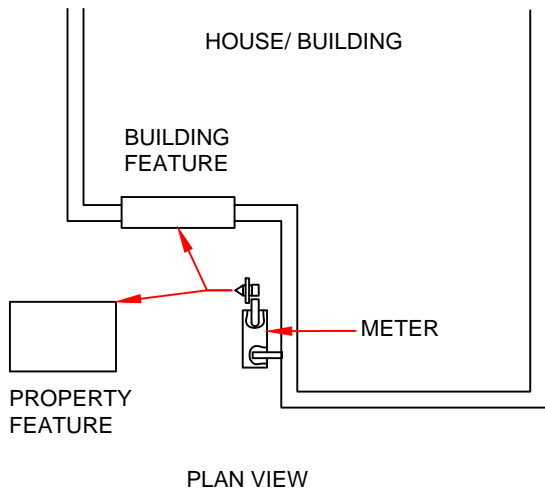

REV.	DESCRIPTION	BY	DATE	CHK	APR
B	REVISED FOR SINGLE STATE	JEH	10/08/24	SM	SM
A	REVISED NOTATION	JEH	10/07/22	SM	SM
REVISIONS					

DRAWN	JNM
CHECKED	CL
APPROVED	CL

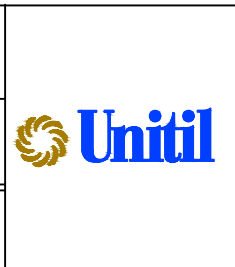

UNITIL GAS STANDARDS (MA) GAS METER SET ASSEMBLIES INSTALLATION REQUIREMENTS			
SCALE	DATE	SHEET	DRAWING NO.
N/A	10/8/24	3 OF 7	UAYMX006

DIAGRAM D

REGULATOR RELIEF VENT CLEARANCES FROM FEATURES

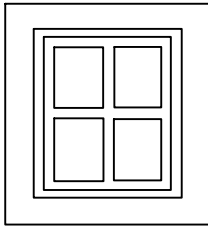

WINDOW OPENING

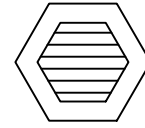

ATTIC VENT OPENING

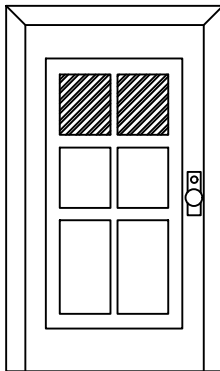

DOORS

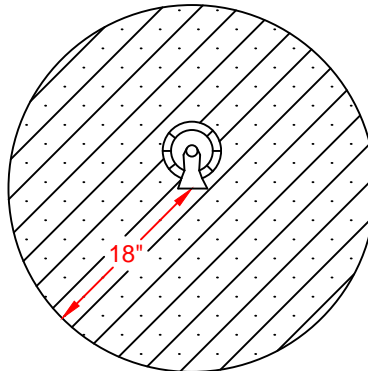

NO FEATURES TO BE PLACED WITHIN TOLERANCE ZONE (CROSS-HATCHED AREA)

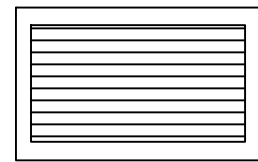

AIR INTAKE OPENING

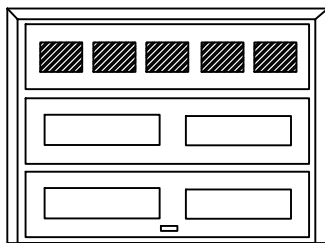

GARAGE DOORS



CRAWL SPACE OR GARAGE VENT OPENING

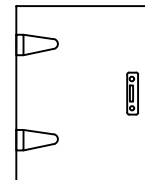

FIREPLACE CLEANOUT OPENING

REV.	DESCRIPTION	BY	DATE	CHK	APR
A	REVISED FOR SINGLE STATE	JEH	10/08/24	SM	SM
REVISIONS					

DRAWN	JNM
CHECKED	CL
APPROVED	CL

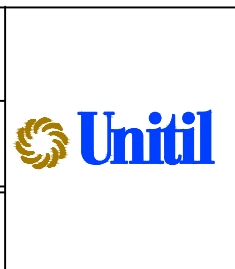

UNITIL GAS STANDARDS (MA) GAS METER SET ASSEMBLIES OPENING FEATURES			
SCALE	DATE	SHEET	DRAWING NO.
N/A	10/8/24	4 OF 7	UAYMX006

DIAGRAM E

REGULATOR RELIEF VENT CLEARANCES FROM FEATURES

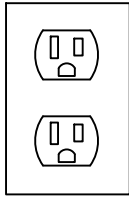

ELECTRIC OUTLET

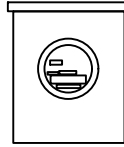

ELECTRIC METER

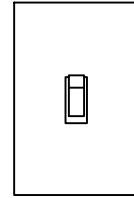

WALL SWITCH

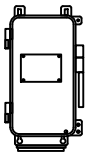

DISCONNECT

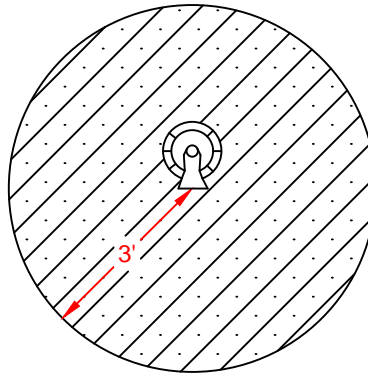

NO FEATURES TO BE PLACED
WITHIN TOLERANCE ZONE
(CROSS-HATCHED AREA)

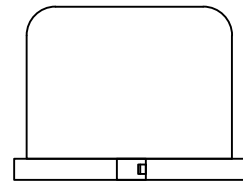

GENERATOR OR
TRANSFORMER

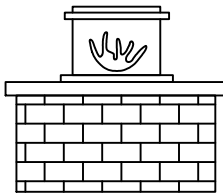

OPEN FLAME OR
PERMANENT BBQ

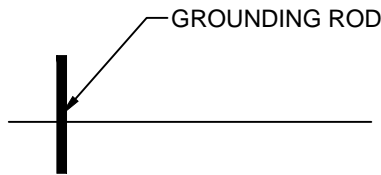

GROUNDING ROD

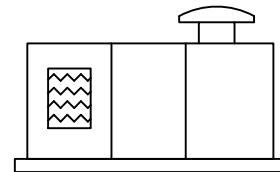

INCINERATOR

REV.	DESCRIPTION	BY	DATE	CHK	APR
A	REVISED FOR SINGLE STATE	JEH	10/08/24	SM	SM
REVISIONS					

DRAWN	JNM
CHECKED	CL
APPROVED	CL

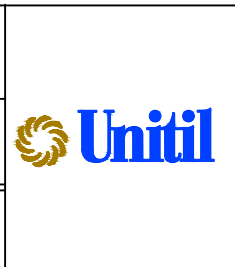

UNITIL GAS STANDARDS (MA) GAS METER SET ASSEMBLIES IGNITION FEATURES			
SCALE	DATE	SHEET	DRAWING NO.
N/A	10/8/24	5 OF 7	UAYMX006

DIAGRAM F

REGULATOR RELIEF VENT CLEARANCES FROM FEATURES

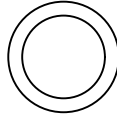

APPLIANCE COMBUSTION
AIR INTAKE VENT OPENING

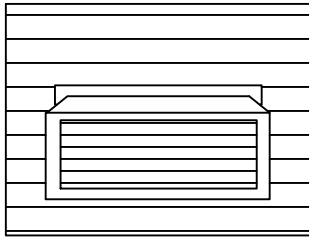

WALL MOUNTED
AIR CONDITIONER

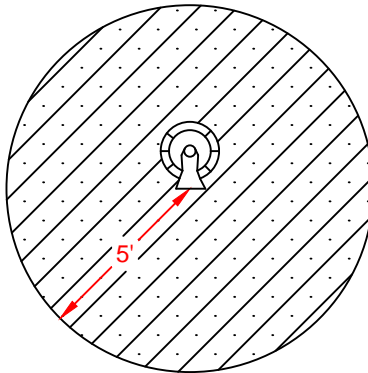

NO FEATURES TO BE PLACED
WITHIN TOLERANCE ZONE
(CROSS-HATCHED AREA)

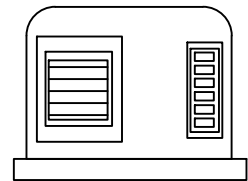

AIR CONDITIONER
OR HEAT PUMP

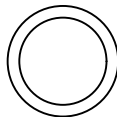

APPLIANCE EXHAUST
VENT OPENING

REV.	DESCRIPTION	BY	DATE	CHK	APR
A	REVISED FOR SINGLE STATE	JEH	10/08/24	SM	SM
REVISIONS					

DRAWN	JNM
CHECKED	CL
APPROVED	CL

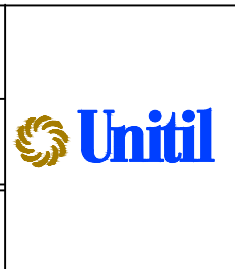

UNITIL GAS STANDARDS (MA) GAS METER SET ASSEMBLIES FORCED AIR INTAKE			
SCALE	DATE	SHEET	DRAWING NO.
N/A	10/8/24	6 OF 7	UAYMX006

DIAGRAM G

REGULATOR RELIEF VENT
CLEARANCES FROM FEATURES

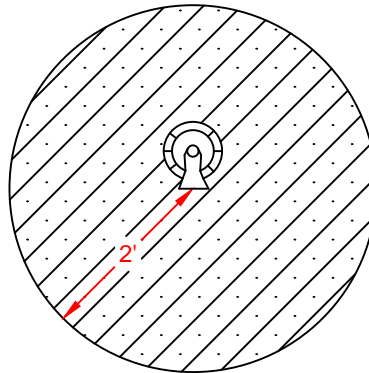

NO FEATURES TO BE PLACED
WITHIN TOLERANCE ZONE
(CROSS-HATCHED AREA)

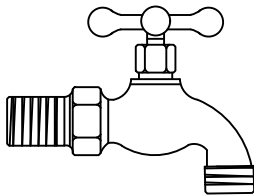

WATER SPIGOT

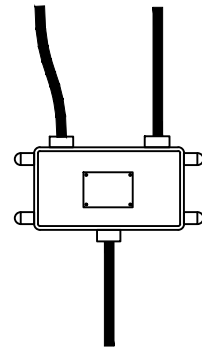

COMMUNICATIONS BOX

						DRAWN					
						JNM		UNITIL GAS STANDARDS (MA)			
						CHECKED		GAS METER SET ASSEMBLIES			
						CL		OTHER FEATURES			
A	REVISED FOR SINGLE STATE	JEH	10/08/24	SM	SM	APPROVED	SCALE	DATE	SHEET	DRAWING NO.	
REV.	DESCRIPTION	BY	DATE	CHK	APR	CL	N/A	10/8/24	7 OF 7	UAYMX006	
REVISIONS											